



1002HL- 14300XLR-SMC HEXSCREEN ELECTRIC THRUSTER



- No maintenance for 5 years or 5,000 hours other than oil changes.
- No disassembly required for fresh water rinsing.
- Streamlined Brushless DC, oil filled and pressure balanced motors.
- True direct drive electric motors. No gearbox, no magnetic coupling, nor any other device to transmit power, simplifying the design and increasing reliability.
- The venturi shape of the 1002 Series Thrusters are ideally suited for Electric Drive since the Propeller Turns Faster for the Same Power.
- Proven 3 tier seal system that includes Silicone Carbide Face Shaft Seals.
- 90% Reverse Thrust
- High Efficiency and Much Faster Response Time. Thrusters that will make a difference to any ROV's / Submarines performance
- All USA made materials, manufacturing and assembly.
- Independently Tested Off-The-Shelf Units that have a proven track record.

PRECISION DESIGNED AND BUILT - COMPARE EFFICIENCIES & PROP TIP CLEARANCES.

- Optional Hexscreens of Hydrodynamic Design Protects Divers & the Propeller.
- The Hexscreens Cancels 80% of the Propeller Torque While Reclaiming Thrust by Reducing the Jet Whirl. Makes for a more energy efficient & Steadier Vehicle.

Customized Solutions/Systems for R & D Programs or Prototype Vehicles, small or large. These thrusters can be precision matched to each application.



PERFORMANCE DATA & THRUSTER DIMENSIONS

1002HL- 14300XLR-SMC Motor Specifications				
Input Voltage	Max Thrust	RPM	Input Power	Shaft Power
300 VDC	546 lbf (248 kgf)	2,400	18.7 HP (13.9 kW)	17.9 HP (13.4 kW)
Reverse Thrust				
300 VDC	495 lbf (225 kgf)	2,400	18.7 HP (13.9 kW)	17.9 HP (13.4 kW)

1002HL Hexscreen Electric Thruster with 14300XLR Motor Performance Table

Speed (RPM)	System Voltage (VDC)	Min Voltage (VDC)	Current (A rms)	Bollard Thrust		Reverse Thrust		Power Shaft		Power In		Efficiency (Pout/Pin)
				0 (Lbf)	0 (Kgf)	(Lbf)	(Kgf)	(HP)	(Watts)	(Watts)	(HP)	
100	300	12.2	0.9	1	0.4	1	0.4	0.02	13	13	0.0	97.7%
200	300	24.0	1.1	4	1.7	3	1.6	0.04	31	32	0.0	98.6%
400	300	47.9	2.0	15	6.9	14	6.2	0.14	108	109	0.1	98.8%
600	300	72.1	3.4	34	15.5	31	14.0	0.37	275	279	0.4	98.6%
800	300	96.5	5.3	61	27.5	55	25.0	0.78	579	588	0.8	98.3%
1000	300	121.2	7.8	95	43.0	86	39.0	1.43	1064	1085	1.5	98.1%
1200	300	146.1	10.8	137	62.0	124	56.1	2.38	1775	1816	2.4	97.8%
1500	300	184.1	16.4	213	96.8	193	87.7	4.51	3368	3461	4.6	97.3%
1800	300	222.7	23.3	307	139.4	279	126.3	7.68	5726	5913	7.9	96.8%
1900	300	235.6	25.8	342	155.3	310	140.8	8.99	6708	6940	9.3	96.7%
2000	300	248.7	28.5	379	172.1	344	156.0	10.45	7798	8081	10.8	96.5%
2100	300	261.8	31.4	418	189.7	379	171.9	12.07	9002	9343	12.5	96.3%
2200	300	275.0	34.4	459	208.2	416	188.7	13.84	10325	10734	14.4	96.2%
2300	300	288.3	37.5	502	227.6	455	206.3	15.78	11773	12259	16.4	96.0%
2400	300	301.6	40.7	546	247.8	495	224.6	17.90	13351	13925	18.7	95.9%

Table Information:

- 1) The Minimum Voltage column in the above table shows the minimum Voltage needed to achieve the performance at that corresponding propeller RPM/Thrust.
- 2) The Current shown represents the continues RMS Current to the motor to achieve the Thrust at the corresponding propeller RPM.
- 3) The Shaft HP developed is a function of the propeller and increases with propeller RPM.
- 4) The maximum performance achieved will depend on the limitations of customers system Voltage and driver Current capacity.
- 5) For Thrust at Forward Vehicle Speed (Kts), anything lower than 500 RPM varies greatly with vehicle design.
- 6) The Current/RPM might need to be limited depending on customer connector spec and or system Current limitations.
- 7) Minimum Voltage to achieve full Thrust is 302 VDC.
- 8) Max Voltage should not exceed 10% of rated Voltage.



1002HL- 14300XLR Dimensions

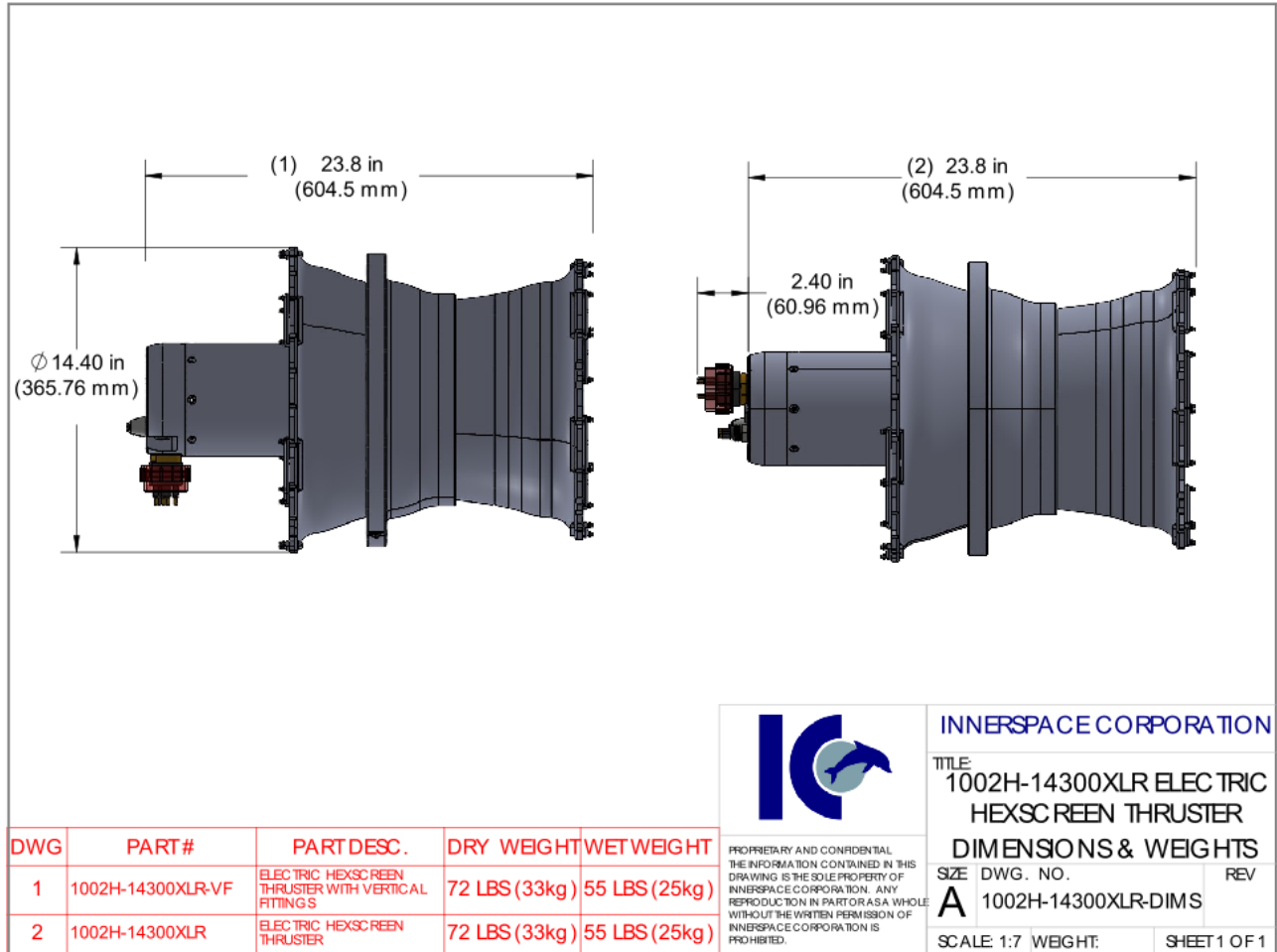

The Electric Thrusters can be ordered with almost any customer preferred connectors if Current ratings are taken into consideration.

The above Drawing shows the 1002HL-14300XLR Thruster Dimensions with Vertical Fittings/Bulkheads (1) and Axial fittings/Bulkheads (2).



GENERAL ARRANGEMENT

14300XLR BDC MOTOR

DIRECT DRIVE – Propeller Attached on the same shaft that the Magnets are on without any other device to transmit power to the Propeller.

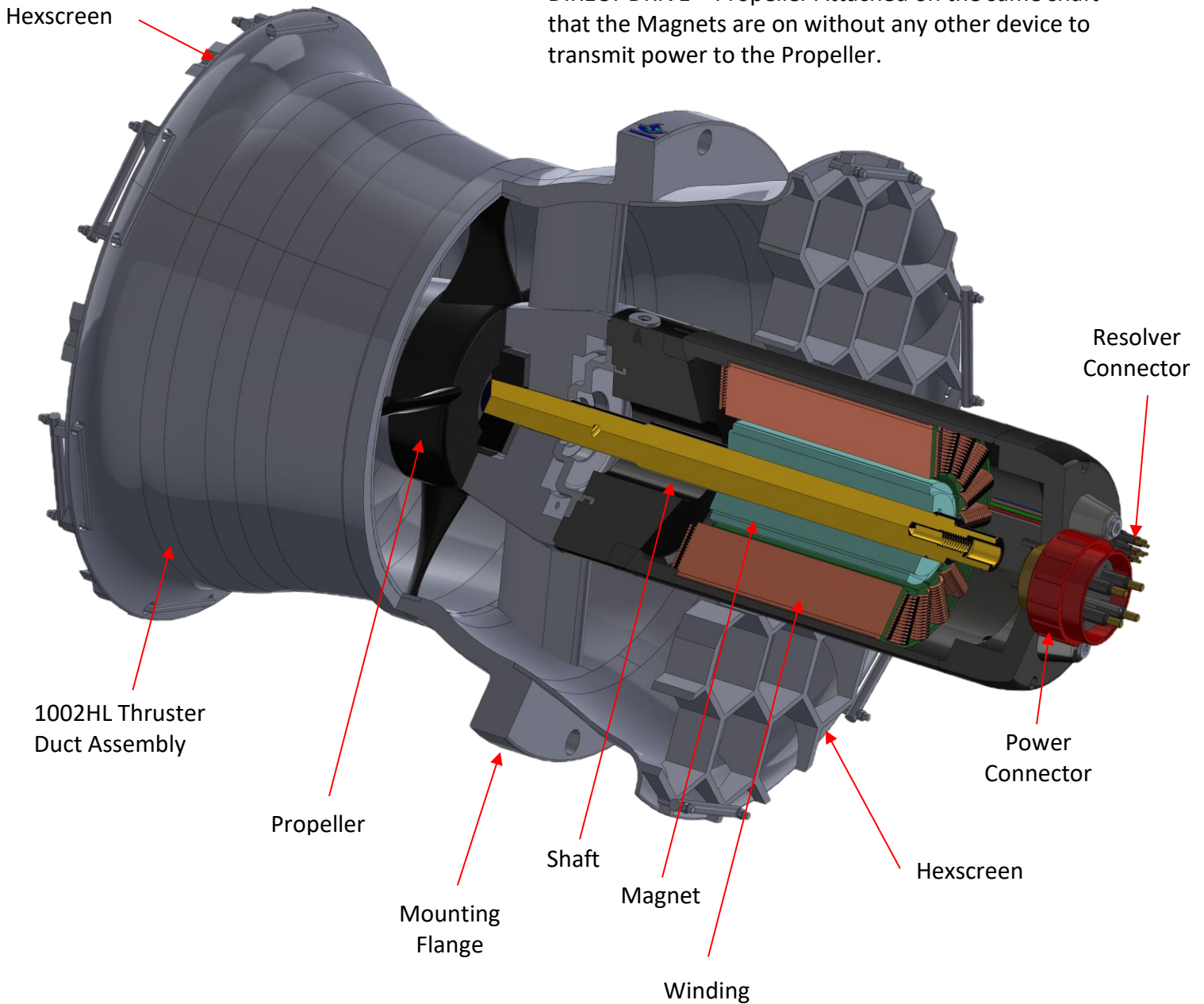



STATE-OF-THE-ART AMBIENT PRESSURE MOTOR CONTROLLER FROM 50 – 780 VDC

The 1002 Series Electric Thrusters are offered with a matching SMC (Stand-alone Motor Controller) housed in a separate one atmosphere bottle. Specially designed to match the 1002 Series Electric Thruster range from Innerspace, the SMC controller operates in torque or velocity mode. Torque mode is particularly useful when integration to a vehicle stability control system is anticipated, allowing percentage torque thrust forward and reverse to the RPM limit of the motor. Feedback from the motor to the system controller receipt of the digital commands sent and provides real time RPM and motor Current, along with system health and performance monitoring data. Motor acceleration rates and other parameters can be set to suit the motor and application.

Recording of lifetime performance data including total shaft revolutions, hours since overhaul and power cycles provide data points for operation and maintenance purposes are standard.



Stand-alone Motor Controller (SMC)
Sizes will vary depending on depth.



INNERSPACE CORPORATION

1138 E. EDNA PLACE, COVINA, CA 91724

TEL: (626) 331-0921 FAX: (626) 966-6391

www.innerspacethrusters.com

SPECIFICATIONS

SMC (Stand-alone Motor Controller):

Type:

Atmospheric Pressure Housed Three Phase BLDC motor controller.

Available Configurations:

Stand Alone (SMC): Independent control unit with cable connections to motor - phase (power) and sensing (resolver) Communication (Network).

Motor Power Rating: 1hp (750W) to 25hp (18kW) with options to 55hp (41kW)

General Characteristics:

Voltage: DC, 50VDC to 780VDC, Positive, Negative, Isolated from Frame Ground.

Current: Maximum Continuous 50A (in water)

Motor Type: Suitable for Three Phase water cooled BLDC Permanent Magnet motors

Operating Parameters: Stand Alone Controller: Sine/CoSine resolver and direct commutation
Controller parameter matched to associated motor.

Connections

Power: Subconn HPBH4M - Positive, Negative and Frame Safety Ground

Data: SubConn DBH13M – 1. 24V+, 2. SHD, 3. 0V-, 4-7 RESERVED, 8. ECAT TX+, 9. ECAT TX-, 10. ECAT RX+, 11. ECAT RX-, 12 & 13 RESERVED

Motor Phase: Subconn HPBH4F - Phase A, B, C, Frame Ground/Shield

Motor Sensor: Subconn DBH8F Sensor SIN+/-, COS+/-, EXC+/- Frame Ground/Shield

Control

Electrical: Ethercat point to point connection.

A separate 24VDC LV supply used with the Ethercat connection. This enables the condition of the controller to be known without the HV being present. Communication of all the motor parameters is possible.

Command: Over 300 commands available please contact for requirements

Ethercat SDO and PDO:

Action Commands: RPM setting (velocity mode) - Forward and Reverse, to rated motor RPM

Power setting (torque mode)- Forward and Reverse, 0% to 100% of maximum rated/programmed torque

Safety Lockout (Manual)

Status query

Status Messages: Shaft RPM

Motor Current

Throttle/Thrust setting

Temperature

Safety State Action: Condition warnings (Temperature, Voltage, Current)

Control System Connectivity Failure - Automatic shutdown

Notes:

- Optional External Control Interfaces: Test interface and development code
- DC supply cables must meet minimum length/inductance requirements to eliminate requirement for an external HVDC soft start switch.
- Adequate DC bus capacitance and reverse EMF/Overvoltage protection must be used.
- All Data cable must be shielded for noise prevention
- Data cable should not exceed 6 meters between SMC and electric motors.